

# ASSAM POWER GENERATION CORPORATION LIMITED

OFFICE OF THE CHIEF GENERAL MANAGER (HYDRO & CIVIL),

BIJULEE BHAWAN, GUWAHATI-781001



NIT NO: - E-Tender Notice No. 09 of 2021-22 of CGM (H&C) dtd: 28.03.2022

NAME OF THE WORK: 1 (A) Construction of stone rubble masonry retaining wall & drain for 1<sup>st</sup> bench at newly excavated area on left bank of upstream side at Dam site of KLHEP.

1(B) Construction of stone rubble masonry toe wall & drain for 1<sup>st</sup> bench at newly excavated area on left bank of upstream side at Dam site of KLHEP.

1(C) Construction of 2 nos. stone masonry catch pit at 1<sup>st</sup> bench of newly excavated area on left bank of upstream side at Dam site of KLHEP.

Issued to:

Name:-

Address: -

Issued by:

Price: - —600/-  
(Non-Refundable)

March-2022

INDEX

<u>Chapter</u>		<u>Page No</u>
Chapter-I	Tender Notice	..... 2
Chapter-II	Terminology	..... 4
Chapter-III	Instruction for bidders and special Conditions	..... 5
Chapter-IV	Safety Engineering and Safety Code	..... 11
Chapter-V	Contractor's Camp	..... 12
Chapter-VI	Declaration	..... 13
Chapter-VII	Declaration of litigation	..... 14
Chapter-VIII	Schedule of works	..... 15
Chapter-IX	Drawings	..... 21

## CHAPTER-I

### TENDER NOTICE



## ASSAM POWER GENERATION CORPORATION LIMITED

Registered Office: Bijulée Bhawan, 2<sup>nd</sup> floor, Paltanbazar, Guwahati-781 001, Assam.

Email: cgm-h@apgcl.com, Tele-Fax: 0361-2739522.

Chief General Manager (Hydro & Civil)

E-Tender Notice No. 09 of 2021-22 of CGM (H&C)

Dated: 27/03/2022

### Tender Notice No. 09 of 2021 -22

<b>Invitee</b>	The Chief General Manager (Hydro & Civil) 2nd Floor Bijulée Bhawan, Paltanbazar, Guwahati, Assam, PIN-781001
<b>Name of work</b>	<b>1. (A) Construction of stone rubble masonry retaining wall &amp; drain for 1st bench at newly excavated area on left bank of upstream side at Dam site of KLHEP.</b> <b>1. (B) Construction of stone rubble masonry toe wall &amp; drain for 1st bench at newly excavated area on left bank of upstream side at Dam site of KLHEP.</b> <b>1. (C) Construction of 2 nos. stone masonry catch pit at 1st bench of newly excavated area on left bank of upstream side at Dam site of KLHEP.</b>  <b>2. (A) Construction of stone rubble masonry retaining wall &amp; drain for 2nd bench at newly excavated area on left bank of upstream side at Dam site of KLHEP.</b> <b>2. (B) Construction of stone rubble masonry toe wall &amp; drain for 2nd bench at newly excavated area on left bank of upstream side at Dam site of KLHEP</b> <b>2. (C) Construction of 6 nos. stone masonry catch pit at 2nd bench and 4 nos. stone masonry catch pit at 3rd bench of newly excavated area on left bank of upstream side at Dam site of KLHEP.</b>
<b>Duration of work</b>	1. 60 days from handing over the site 2. 60 days from handing over the site
<b>Tendered value</b>	1. Rs. 29,75,223.00 (Rupees twenty nine lakhs seventy five thousand two hundred and twenty three only ) (inclusive of all taxes)  2. Rs. 40,56,338.00 (Rupees Forty lakhs fifty six thousand three hundred and thirty eight only ) (inclusive of all taxes)
<b>Eligibility of the bidder</b>	Reputed and financially sound Civil Engineering firms / contractors with following Average Annual turnover during last three Financial Years i.e. 2020-21, 2019-20 & 2018-19: <b>1. Rs. 14.88 lakhs (50% of the tendered amount)</b> <b>2. Rs. 20.28 lakhs (50% of the tendered amount)</b>  and having experience of successfully completing similar works during the last 3 years ending last day of month previous to the one in which applications are invited should be either of the following:-  1. a. Three similar completed works costing not less than the amount equal to <b>Rs. 11.90 lakhs (40% of the tendered amount).</b> or b. Two similar completed works costing not less than the amount equal to <b>Rs. 14.88 lakhs (50% of the tendered amount).</b> or c. One similar completed work costing not less than the amount equal to <b>Rs. 23.80 lakhs (80% of the tendered amount).</b> (Supporting documents to be submitted).  2. a. Three similar completed works costing not less than the amount equal to <b>Rs. 16.23 lakhs (40% of the tendered amount).</b> or

	<p>b. Two similar completed works costing not less than the amount equal to <b>Rs. 20.28 lakhs (50% of the tendered amount).</b></p> <p>or</p> <p>c. One similar completed work costing not less than the amount equal to <b>Rs. 32.45 lakhs (80% of the tendered amount).</b> (Supporting documents to be submitted).</p>
<b>Tender fee (Non-refundable)</b>	<p>1. Rs. 600/- (Rupees six hundred only) 2. Rs. 820/- (Rupees eight hundred and twenty only)</p> <p><b>Tender processing fees must be deposited online as per instructions given vide as per OM. No. FEB. 269/2017/27 dated 21.08.2019 (copy enclosed for ready reference). Tender processing fee in any other form will not be accepted.</b></p>
<b>Earnest Money Deposit (EMD)</b>	<p>1. Rs. 59,504.00 (for General) Rs. 29,752.00 (for SC/ST/OBC)(For Individual only) 2. Rs. 81,126.00 (for General) Rs. 40,563.00 (for SC/ST/OBC)(For Individual only)</p> <p><b>EMD amount should be deposited online as per Finance Department Govt. of Assam office memorandum (OM).No. FEB.269/2017/27 dated 21.08.2019 (copy enclosed for ready reference). EMD amount in any other form will not be accepted.</b></p>
<b>Start date of Tender</b>	30/03/2022
<b>Last date and time of online bid submission</b>	10.00 a.m. on 08/04/2022
<b>Tender Opening</b>	01.00 p.m. on 08/04/2022

Bidder must download the Bidding Documents and submit the bid electronically on the portal <https://assamtenders.gov.in>

The Bidders will be required to submit the bids by using own Digital Signature Certificate with both Signing and Encryption Certificates (minimum Class-II Certificate). Prospective Bidders must procure DSC before participating in the tenders. The viewing & downloading of the bid document will be free of cost.

**Bid shall be submitted electronically/ online.**

**The bidder must submit the requisite tender fee and EMD through online as per Finance Department Govt of Assam office memorandum (OM) No. FEB. 269/2017/27 dated: 21.08.2019.**

The Bidders will be required to download the Bidding Documents from the web portals mentioned above. However, they will have to pay a non - refundable tender document fee as mentioned above online, the details of which are stipulated in the tender document. The acceptance of the bid shall be subjected to acceptance of the document fee.

The Chief General Manager (Hydro & Civil), APGCL is not bound to accept the lowest rates and reserves the right to accept or reject any or all tenders without assigning any reason thereof.

Note: Any addendum/corrigendum/extension etc. in respect of this tender shall be issued on the portal <https://assamtenders.gov.in> and APGCL's website: [www.apgcl.org](http://www.apgcl.org).

  
 Chief General Manager (Hydro & Civil), i/c  
 APGCL

## CHAPTER-II

### **1 TERMINOLOGY**

- 1.01** APGCL wherever used in this document shall mean Assam Power Generation Corporation Limited incorporated vide The Companies Act 1961 in exercise of Powers conferred under the Act including subsequent amendments, if any. APGCL is a successor company of ASEB.
- 1.02** CGM (H&C) or owner or purchaser or project authority wherever used in this document shall mean the officer holding the post of the Chief General Manager (Hydro & Civil) APGCL, Guwahati (Assam), who or his authorized representative will exercise authority on behalf of the Department in respect of the Tender and the works specified herein.
- 1.03** Engineer-in-Charge/or engineer shall mean the Officer holding the charge of the Departmental post of General Manager/ Assistant General Manager (Civil) pertaining to supervision of works specified in this document.
- 1.04** The term 'Contractor' wherever used in this document shall mean the individual/firm or company who shall have entered into a contract agreement with the owner or the project authority, undertaking on his behalf to carry out the works in full or in part as may be specified in contract documents, and shall include in the case of an individual/ his heirs, administrators and permitted assignees, in case of a firm, the partners of the said firm, their respective heirs, executors, administrators and permitted assignees, and in case of a Company its successors and permitted assignees.
- 1.05** Contract documents shall mean and comprise the following documents and shall be the basis of agreement between the owner and the contractor for carrying out the works in accordance with the terms and conditions, specifications, drawings and directions contained in the said documents.
- a) Bid documents duly filled in respect of rates, process & signed, the tender forms properly filled in, signed and dated by the contractor & duly submitted.
  - b) Contractor's original bid proposal and subsequent correspondences relating to clarifications and negotiations, if any, prior to award of the contract.
  - c) Equipment, specifications and drawings, so far as applicable
  - d) Approved agreement forms duly signed, dated and sealed by the contractor and the owner as specified in the said forms
- 1.06** 'Equipment' and 'Plants' shall mean and include all sorts of machineries and accessories, apparatus, instruments, components manufactured articles and parts etc. to be supplied or provided by the contractor under the terms of the contract , unless otherwise specified
- 1.07** The 'Works' shall unless be repugnant to such description shall be construed and taken to mean the works contracted, or by virtue of the contract agreement, to be executed whether temporary or permanent and whether original, altered, substituted or additional.
- 1.08** The expression 'Specifications' wherever used in this document shall mean all the pertinent terms and stipulations furnished herein in respect of the work or part thereof and/or indicated in the drawings appended hereto and to be issued for construction and shall have reference also to other relevant terms and stipulations not furnished herein, but as far as applicable.

## CHAPTER-III

### INSTRUCTION FOR BIDDERS AND SPECIAL CONDITIONS

**NIT No.:** E-Tender Notice No. 09 of 2021-22 of CGM (H & C) Dated: -28/03/2022

#### **BID INVITATION FOR:**

1(A) Construction of stone rubble masonry retaining wall & drain for 1st bench at newly excavated area on left bank of upstream side at Dam site of KLHEP.

1(B) Construction of stone rubble masonry toe wall & drain for 1st bench at newly excavated area on left bank of upstream side at Dam site of KLHEP.

1(C) Construction of 2 nos. stone masonry catch pit at 1st bench of newly excavated area on left bank of upstream side at Dam site of KLHEP.

**EARNEST MONEY DEPOSIT:**                 Rs.59,504.00 (for General)  
  Rs.29,752.00 (for SC/ST/OBC) (For Individual only)

1.       **DUE DATE AND CLOSING TIME**

The bid will be received up to 10.00 A.M. of 08/04/2022. The opening time of the bids will be at 1.00 p.m. on the same day and the venue will be the office of the Chief General Manager (Hydro & Civil), APGCL.

2.       **TIME OF COMPLETION OF WORK**

The stipulated time of completion of the work is **60 (Sixty) days** from the date of handing over the site. **No time extension shall be granted to the contractor irrespective of size and volume of the awarded work.**

3.       **BID-GUARANTEE OR EARNEST MONEY DEPOSIT: (E.M.)**

3.1      Every bid or tender shall be accompanied by a deposit of E.M for an amount indicated in the Tender Notice pertaining to the work (ordinarily equivalent to 2% of the estimated value of work, unless otherwise specified in the Notice), in the form of an acceptable **Demand Draft only from a Nationalized/Schedule Bank pledged in favour of the Deputy General Manager (F & A), APGCL, Guwahati.** Irregular tender is liable to be rejected.

3.2      The E.M. as mentioned above will be returned to the respective unsuccessful bidder soon after the award of the contract. The E.M. will be retained towards the contract security deposit in the case of selected bidder or bidders in whose favour the contract is awarded. The APGCL will not entertain any claim for release of the E.M. during pendency in selection of contractors for awarding the contract. The APGCL will not pay any interest on the E.M. deposit.

3.3      The E.M. is liable to be forfeited in the absolute discretion of the CGM (H&C), APGCL, if a selected bidder revokes or causes to withdraw his offer / tender before the expiry of its validity or fails after the contract is awarded to him to execute the 'Contract agreement' with the APGCL described herein after (so far as applicable) or to commence the work within the period as notified in the work order.

4.       **PERFORMANCE –GUARANTEE OR SECURITY DEPOSIT (S.D.)**

4.1      The security to be taken for due performance of the contract in terms of the 'contract agreement' will be a deduction of 10% (ten percent) from every ad-interim payment made on account of works performed, until the sum of these deductions and E.M. together becomes equal to 10 (ten) percent of the total executed value.

4.2      Such S.D. shall be forfeited or appropriated by the CGM (H&C), APGCL, BijuleeBhawan, Guwahati under authority of the owner in his discretion towards any loss, damage etc. that may

be sustained by the APGCL as a result of breach of any terms, conditions of the contract by the contractor, notwithstanding other remedies open to the APGCL under the terms of the contract or law.

- 4.3 In the event of contractor's Security Deposit being appropriated towards loss, damage etc, the contractor shall forthwith recoup the amount to restore the Security Deposit to the full current value within 30 (thirty) days from the date of intimation.
- 4.4 Subject to the provisions mentioned above and the provisions of guarantee period of one year, the Security Deposit will be returned to the contractor on the due and satisfactory completion of the contract and after all claims of the APGCL shall have been settled. The APGCL will not pay any interest on the amount of Security Deposit of Performance Guarantee. If the work gets damaged during the defect liability period due to default of the contractor or even otherwise (including due to force majeure) the CGM (H&C) reserves the right to forfeit the SD Money.

**5. GST / INCOME TAX CERTIFICATE (PAN / GST):**

- 5.1 The offered rates and / or prices for the work shall include all taxes, duties, forest royalties, monopolies etc. as may be applicable on material and labour during the tenure of the contract. There will be no reimbursement for any increase or levy of new taxes, duties etc. on materials utilized for this work or equipment furnished / supplied for completing the work or for machineries, equipment, tools and tackle, fuel and lubricants etc. used in connection with the performance of the work, unless otherwise specified or qualified by the bidder in his bid. If, however, any tax or duty is levied by the Govt. or statutory body on the finished work (after complete installation and / or delivery), such tax or duty will be to the account of the APGCL.
- 5.2 **The contractors must have a Active GST Registration No. and should submit copy of GST Certificate and attested copy of PAN Card.**
- 5.3 **Caste certificate must be produced where necessary.**
- 5.4 Copy of acknowledgement of ITR filled for preceding two financial years and an undertaking regarding ITR filling for preceding two financial years immediately before the FY in which tax is required to be deducted

**6. BIDDER'S QUALIFICATIONS:**

- 6.1 The Bidder should submit a list and description of similar or comparable works previously executed by him successfully during last 7 (seven) consecutive years indicating the individual volume and contract price along with the name and address of the respective owner / authority.
- 6.2 All prospective bidders are hereby notified that, before any bid submitted in response to this invitation is considered for award, the CGM (H&C), APGCL may require the bidder to submit a further statement of facts in detail as to the previous experience of the bidder and financial resource available with him for performing the contemplated work. The CGM (H&C), APGCL expressly reserves the right to reject any bid or which the facts as to business, financial and other resources or business experience, compared with the work bid upon, justify such rejection.
- 6.3 The Bidder should submit valid **Labour License Certificate**.
- 6.4 Civil Engineering firms/contractors with adequate experience of having successfully completed **similar works during the last 3 years** ending last day of month previous to the one in which applications are invited should be either of the following:-
- a. Three similar completed works costing not less than the amount equal to **Rs. 11.90 lakhs (40% of the tendered amount)**.
- or
- b. Two similar completed works costing not less than the amount equal to **Rs. 14.88 lakhs (50% of the tendered amount)**.
- or
- c. One similar completed work costing not less than the amount equal to **23.80 lakhs (80% of the tendered amount)**.
- They must submit such completion certificate with the tender.
- 6.5 Cost overrun shall not be accepted.
- 6.6 Contractors should be financially sound to invest the amount and should submit necessary evidence on this account. **Average Annual turnover during last three Financial Years i.e. 2020-21, 2019-20 & 2018-19 should not be less Rs. 14.88 lakhs (50% of the tendered**



**amount**). However, annual turnover certificate of each of the three financial years mentioned above must be submitted.

6.7 It should be ensured that the contractors shall have **Provident Fund Code No.** It will be ascertained that all the workers engaged by the contractor directly should be registered for Employees' Provident (EPF) and due contribution have been credited into their account.

## **7. BIDDER SHOULD EXAMINE & UNDERSTAND**

7.1 All prospective bidders are required to thoroughly study and carefully examine all the terms and conditions, instructions, drawing & specifications pertaining to the work and visit the field of work to fully satisfy and acquaint themselves about the nature and location of work, the configuration of the ground. The spring level, the surface conditions, quality and quantity of materials required and their availability the type of equipment and facilities needed preliminary to and during the execution of the work and local conditions which may affect the work or cost thereof. Failure to do so will be at the bidder's risk.

## **8. SUBMISSION OF TENDER**

8.1 Bidders are to quote their rates against each item in clear money (Rupees) value per unit of work (inclusive of all taxes) in the prescribed format.

8.2 **The rates are to be quoted on item rate basis. The rates are to be quoted in figures.**

8.3 **The rates quoted by the bidders will be inclusive of all taxes, royalties and other statutory levies as applicable.**

8.4 **Bidders should note that unusually low rates not feasible for execution may not be technically accepted.**

8.5 Bidders should note that during the time of execution of work, any item not covered by the schedule of work if required to be done as per decision of the CGM (H&C)/ Engineer-in Charge of APGCL, they have to execute such work/works as supplementary item of works, rates of which will be calculated by using the following formulae:

$$R = (T'/T) * P$$

Where, R= Rate of supplementary item of work

T'= Bid value

T= Tendered value

P= Accepted Rate for the work as per respective S.O.R. of APWRD

If the rate of such supplementary item/items is/are not available in the aforesaid S.O.R, the same will be analyzed by the department as per reasonable market price but in any case of dispute for rate of supplementary item/items, the decision of CGM (H&C) will be final and conclusive.

8.6 **The quoted rates will be firm for entire period of completion of the work. No price escalation on any component will be admissible.**

8.7 Firms submitting tender should enclose a certified copy of the Firm's constitution and a certified copy of Power of Attorney authorizing a person to operate the tender and contract and should furnish full address of the partners and the persons holding power of attorney on behalf of the firm.

8.8 **Information regarding litigation, current or during the last five years, in which the Bidder is involved with APGCL/AEGCL/APDCL, must be furnished, if any in the prescribed format( at Chapter VII).**

8.9 In the event of the date specified for bid receipt and opening being declared as a closed holiday for Purchaser's office, the due date for submission of bids and opening of bids will be the following working day at the appointed date and place.

8.10 The Corporation cannot be held responsible for non-receipt and postal delay.

8.11 Every page of the tender document to be duly signed by the bidder.

## **9. AWARD OF CONTRACT**

9.1 The contract will be awarded to that responsible bidder whose bid, confirming to the schedule conditions of contract and specifications will be most advantageous to the Department, price and other factors considered. An award mailed (or otherwise furnished) to the successful bidder within the time for acceptance specified in the bid will result in a binding contract without



further action by either party. The CGM (H&C), APGCL does not bind itself to accept the lowest bid or any bid. As the interest of the Department may require, the right is reserved to reject any or all bids and to waive any minor informality or irregularity in bids received without assigning any reason thereof. Bid which are incomplete or which contain undesirable conditions are liable to rejection.

9.2 **APGCL will try to make timely payment of bills, but on unavoidable circumstances cannot guarantee timely payment of bills, for which no interest on the payable amount will be entertained.**

## **10. CONTRACT AGREEMENT**

10.1 The 'Contract agreement' (or Tender Agreement) for the works will be drawn up with the selected bidder/bidders within 7 (Seven) days of issue of the work order and the contract documents will comprise as described herein before.

10.2 The conditions of the F-2 form shall form part and parcel of the agreement. However wherever there is any contradiction or variation between the conditions of the F-2 form, the terms and conditions specified elsewhere in this document, the later will be treated as superseding the former. Terms and conditions shall be as per F-2 Form of agreement and has to follow accordingly. In the Form-F-2 all the designations appearing as Executive Engineer/Sub divisional Officer shall be read as Chief General Manager (Hydro & Civil), Assam Power Generation Corporation Limited (herein after called as C.G.M (H&C), APGCL).

10.3 In a case where the selected bidder fails to commence the work as shall be notified in the work order or fails to execute the tender agreement with the CGM (H&C), APGCL as stipulated herein before; the CGM (H&C), APGCL reserves the right to claim loss, damage etc. and take appropriate action under the terms of this document or law including forfeiture of E.M.

## **11. TOOLS & PLANTS**

11.1 The APGCL shall not furnish any tools & tackle, plants and equipment or such facilities for carrying out the work by the contractor (excluding hypothecation). The contractor shall arrange and maintain the equipment required for implementation of work all throughout the period of the contract.

## **12. MATERIALS & LABOUR**

12.1 All materials (this includes without limitation raw materials, parts, components etc.) and labour required for carrying out the work shall be arranged and furnished by the contractor all throughout the tenure of the contract and strictly conform to relevant IS Code ( latest revision).

12.2 The intending tenderers should inspect the prospective sources of collection of raw materials and fully satisfy him about the quality of materials, availability of materials, lead, and mode of transportation. The Department shall not consider, after acceptance of the contract, to pay any extra charge for lead or any other reasons, in case the contractor found later on, to have misjudged, the quality/quantity of availability of such materials from the source of collection.

12.3 APGCL shall not issue any construction materials such as cement, reinforcement bar, or any other materials.

12.4 In connection with the performance of work throughout the tenure of the contract, the engagement of labour and payment therefore by the contractor shall conform to the statute, the pertinent law or act of the Central & State Govts, as well as rules, regulations and orders of the local authorities or statutory bodies, as may be in force from time to time.

12.5 The materials procured for the work by the contractor shall be placed at site properly for inspection of Engineer-in charge before utilization. Any defecting materials should be replaced immediately for which no extra charge will be payable to the contractor.

## **13. CHANGES IN QUANTITY AND ITEM**

13.1 The CGM (H&C), APGCL may at any time, by a written order make changes within the general scope of the contract, in any one or more of the following

- i) Quantity of any item
- ii) Alteration or omission of any item
- iii) Addition of any item
- iv) Alteration in drawings, designs or specifications

If any such change causes an increase or decrease in the cost of or the time required for performance of the contract, an equitable adjustment shall be made in the contract price or time schedule or both and the contract shall be modified in writing accordingly. Any claim by the contractor for adjustment under this clause must be asserted within 30 days from the date of receipt by the contractor of the notification of change: PROVIDED HOWEVER, that the CGM (H&C) if decides that the facts justify such action, may receive and act upon any such claim asserted at any time prior to final payment under the contract. Failure to agree to any adjustment shall be a dispute concerning a question of fact within the meaning of the disputes mentioned herein after. However nothing in this clause shall excuse the contractor from proceeding with the contract as changed.

#### **14. INSPECTION**

- 14.1 All works and all supplies (this term includes without limitation raw materials, parts, components, intermediate assemblies and end products) under the contract shall be subject to inspection and test by the CGM (Hydro & Civil), APGCL or his authorized person to the extent practicable at all times and places including the period of construction or manufacture and in any event prior to final acceptance.
- 14.2 In case any work or part thereof or/and any supply is found defective in material or workmanship or otherwise not in conformity with the specifications or drawings or requirements of the contract, the CGM (Hydro & Civil), APGCL shall have the right either to reject them or to require their correction, as directed by the department.
- 14.3 The inspection and test by the CGM (Hydro & Civil), APGCL or his authorized person of any work or any supplies does not relieve the contractor from any responsibility regarding defects or other failures to meet the contract requirements which may be discovered prior to final acceptance. Except as otherwise provided in this contract final acceptance shall be conclusive except as regards latent defects, fraud or such gross mistakes as amount to fraud.
- 14.4 The contractor shall provide and maintain an inspection system acceptable to the CGM (Hydro & Civil), APGCL covering the works and/or supplies hereunder. Records of all inspection works by the contractor shall be kept complete and available to the CGM (Hydro & Civil), APGCL during the performance of this contract.

#### **15. FORCE MAJEURE**

- 15.1 Force Majeure shall cover only act of God, Fire, War, Strikes, Riots and Civil Commotion, Act of Government etc. Any constraints other than those specified above will not constitute force majeure condition. In view of the other constraint beyond the control of the Contractor primarily due to statutory compulsion, extension of execution may also be considered on individual merit of the case. In case of Force Majeure condition the contractor shall notify such condition to CGM (H&C) within 15 (fifteen) days from the beginning of such delay in writing for consideration and acceptance.
- 15.2 **It may be noted that in the event of Geological surprises/problems, the work may need to be stopped for some time at the discretion of the engineer in charge. The stoppage period shall be excluded from the time period allotted for completion of the work. The time of completion shall be accordingly adjusted for such stoppage of work, if any.**

#### **16. LIQUIDITY DAMAGE**

- 16.1 The liquidated damages shall be payable for delay in completion of the work @ 1 % (one percent) of the executed value per week. The liquidated damages so payable shall not exceed 10% (ten percent) of the executed value. However, the payment of liquidated damages shall not in any way relieve the Contractor from any of its obligations to complete the works or from any other obligations and liabilities of the Contractor under the Contract.

#### **17. TERMS OF PAYMENT**

- 17.1
- 1) **1st and Final Account Bill shall be entertained only after completion of 100% of work.**
  - 2) Bills shall be entertained on the basis of actual measurement of completed works as per standard procedure. The quantity of items mentioned in the BOQ may vary depending upon the site conditions.
  - 3) Every payment shall be made subject to the availability of fund.

**18. CONTRACTUAL FAILURE:**

18.1 In the event of Contractual Failure of any respect on the part of the successful bidder, APGCL shall be entitled to forfeit the EMD or any money received from the bidder and may take appropriate action under the terms of the Contract or Law.

**19. SETTLEMENT OF DISPUTE:**

19.1 In the event of any dispute or differences at any time arising between the parties relating to work or any other clauses or any content of the right and liabilities of the parties or other matters specified therein or with reference to anything arising out of the such dispute or differences shall be endeavored to be resolved by mutual negotiation. If, however, such negotiation is in fructuous, the dispute should be finally settled through Arbitration and Conciliation Act 1996 by three arbitrators appointed in accordance with the said Act. The decision of the arbitrator shall be final & binding upon the parties and the expense of the arbitration shall be paid as may be determined by the arbitrator in accordance with provisions of Arbitration and Conciliation Act 1996. The arbitration proceedings shall be held in Guwahati.

**20. TERMINATION:**

20.1 APGCL may, by not less than 7 (seven) days written notice may terminate the contract, if the contractor:

- i. Fails to remedy a failure in the performance of his obligations,
- ii. Becomes insolvent or bankrupt,
- iii. Submit to APGCL statement which has a material effect on the rights, obligations or interest of APGCL and which the contractor known to be false,
- iv. As result of force majeure, if the whole work cannot be performed for a continuous period of 90 (ninety) days. APGCL shall make payment upon termination to contractor the services performed by the contractor to the entire satisfaction of APGCL prior to date of termination.

## CHAPTER-IV

### SAFETY ENGINEERING & SAFETY CODE

#### 1. SAFETY ENGINEERING

Accident prevention shall be an essential part of the programme of the contractor for all operations involve in performance of the contract under this invitation in order to reduce the cost of construction measures in terms of:

- a. Human life sacrificed
- b. Temporary and permanent injuries to workers.
- c. Loss of materials resulting from accidents.
- d. Loss of damage to equipment.
- e. The cost of workman's compensation insurance.
- f. Loss of times due to accidents.

Suitable safety programme to be developed to cope with the particular hazards for each operations of the performance of the contract.

#### 2. INSPECTION

To ensure effective enforcement of the rules and regulations relating to safety precautions, the arrangements made by the contractor shall be open to inspect by the Engineer-in-Charge or his representative.

#### 3. COMPENSATION

No extra charges or additional compensation will be admissible to the contractor by the department for any work done to comply with the provisions of safety Engineering and Safety Code.

4. The contractor shall be solely responsible for ensuring adequate safety and security of manpower engaged in the work.

## CHAPTER-V

### CONTRACTOR'S CAMP

#### 1. CAMP SITES

The contractor shall provide, maintain and operate under competent direction such camp facilities convenient to the site works under this contract as are necessary for housing, feeding and accommodation of his employees. The location, construction, operation and maintenance of such camps shall be subject to the approval of the Assistant General Manager/ Engineer in charge of the site.

#### 2. USE OF LAND FOR CONSTRUCTION PURPOSES

Such land as may be available at work- site will be allowed to be used by the contractor for construction of his camps free of charge. However, development of clearances of the land will have to be done by the contractor at his own cost. The contractor will be responsible to clear and clean the site after completion of his works and handover the land to the Engineer-in-Charge. The contractor will be liable to pay compensation for any damages done to the land or neighboring area.

#### 3. SANITATION IN CAMP SITE:

The temporary sanitation in the campsite should be properly maintained and hygienic so that pollution can be controlled and just before completion of the work site must be cleared properly.

#### 4. ELECTRICITY SUPPLY:

Electricity supply will be on chargeable basis.

**CHAPTER-VI**

**DECLARATION**

I / We hereby declare that I/we shall treat the tender documents and other records connected with the works as secret/confidential and shall not communicate information derived there from to any person other than person to whom I//We/am/are authorized to communicate the same or use the information to any manner prejudicial to the safety of the state.

Signature of the tenderer

Full Name

(In Block letters)

Address .....

.....

.....

.....

Phone/ Mobile .....

Date: .....

**CHAPTER-VII**

**DECLARATION OF LITIGATION**

Information on litigation history in which bidder is involved

Employer (APDCL/APGCL/AEGCL)	Cause of Dispute	Amount involved	Remarks showing present status



**CHAPTER-VIII**

**Schedule of work:**

**ANNEXURE-A**

To,  
The Chief General Manager (Hydro & Civil),  
APGCL, Bijulee Bhawan,  
Paltanbazar, Guwahati-1

Sub: Submission of tender for the work:-  
**1(A) Construction of stone rubble masonry retaining wall & drain for 1<sup>st</sup> bench at newly excavated area on left bank of upstream side at Dam site of KLHEP.**  
**1(B) Construction of stone rubble masonry toe wall & drain for 1st bench at newly excavated area on left bank of upstream side at Dam site of KLHEP.**  
**1(C) Construction of 2 nos. stone masonry catch pit at 1st bench of newly excavated area on left bank of upstream side at Dam site of KLHEP.**

Ref: Your E-Tender Notice No. 09 of 2021-22 of CGM (H & C) Dated: -28/03/2022

Dear Sir,

In response to your above notice I/We ..... am /are submitting herewith, my / our rates for the work as mentioned below. Necessary documents, as asked for, are enclosed herewith, for your kind perusal.

**(A) Construction of stone rubble masonry retaining wall & drain for 1<sup>st</sup> bench at newly excavated area on left bank of upstream side at Dam site of KLHEP.**

Sl. No.	Description of Item	Unit	Quantity	Rate (Rs.) Including all taxes	Amount (Rs) Including all taxes
1	<b>Excavation of Structures</b> Providing Hydraulic excavator for preparation of site and excavation of structures as per direction of Engineer in Charge (lumpsum)	hour	90.00		
2	<b>Excavation in Hard Rock (blasting prohibited)</b> Excavation for roadway in hard rock (blasting prohibited) with rock breakers including breaking rock, loading in tippers and disposal with a lift upto 1.5 m and lead upto 200 metres, trimming bottom and side slopes in accordance with requirements of lines, grades and cross- sections as per Technical Specification Clause 302.3.5 By manual means	cum	20.00		
3	Providing concrete for plain/reinforced concrete in open foundations complete as per drawings and technical specifications clause 802,803,1202 &1203 With crushed stones PCC grade M10, Nominal 1:3:6(hand mixing)	cum	16.151		
4	Stone masonry in cement mortar for substructure complete as per drawing & technical specification Clauses 702, 704, 1202 and 1204	cum	165.335		

	In cement mortar 1:4				
--	----------------------	--	--	--	--

5	Providing weep holes in brick masonry/stone masonry, plain/reinforced concrete abutment, wing wall, return wall with 100 mm dia PVC pipe extending through the full width of the structures with slope of 1(V):20(H) towards drawing face complete as per drawing and technical specification For weep holes pipe 100 mm dia PVC	Nos.	102		
6	Plastering with Cement Mortar (1:4), 15 mm thick in substructure as per technical specification	Sqm	129.2		
7	Supplying, fitting and placing TMT (Fe-500 D) reinforcement bar (Other ISI approved TMT reinforcement bar (SAI/BISCON/THERMAX or equivalent)) in substructure complete as per drawings and technical specification Clauses 1002, 1005, 1010 & 1202	ton	0.59		
8	Providing and laying filter media with granular crushed aggregates as per specification with smaller size towards the soil and bigger size towards the wall and providing over the entire surface behind abutment, wing wall, return wall to the full height, compacted to firm condition complete as per drawing and technical specification Clause	cum	41.66		
9	Hiring of diesel compressor including all necessary equipments, transportation of machine to and from site, driller, helper and cost of fuel for making drill holes of dia. 20mm and 500mm deep at the top face of concrete column to fix the reinforcement bars. For drilling holes	day	15.00		
10	Supplying :FOSROC LOCK FIX P " agent for fixing the reinforcement bars into the drill holes Supplying :FOSROC LOCK FIX P " agent for fixing the reinforcement bars into the drill holes	litre	13.60		
11	Supplying, fitting and placing TMT (Fe-500 D) reinforcement bar (From Primary Producer: TATA/SAIL/Essex Steel/ Jindal steel/Shyam steel/RINL) in foundation complete as per drawings and technical specifications Clauses 1000 and 1202 Tor for Dowelling for foundation 20mm dia TMT bar @1000 c/c	ton	0.34		
12	Single bamboo spur and palisading of whole 1st class bamboo (Bholuka or Barua) 85 mm to 100 mm dia. Closely packed & driven including fitting, fixing with half 2nd class bamboo (jati or Bethua) horizontally in three rows with cane or tying wire complete and struts 1500 mm apart longitudinally and providing brush wood in the spur as per drawings and technical specifications. Driven at least 900 mm below ground and 1800 mm above ground	rm	37.00		

13	Providing and laying pitching on slopes laid over prepared filter media as per drawing and technical specifications Clause 1302 Stone Boulder	cum	5.00		
14	Gunny Bag	bag	2234.06		
15	Construction of embankment with approved material obtained from borrow pits with a lift upto 1.5 m, transporting to site, spreading, grading to required slope and compacting p g to meet requirement of Tables 300.1 and 300.2 with a lead upto 1000 m as per Technical Specification Clause 301.5 Private Land	cum	715.00		
<b>(A) Total (Rs.)</b>					

**(B) Construction of stone rubble masonry toe wall & drain for 1st bench at newly excavated area on left bank of upstream side at Dam site of KLHEP.**

Sl. No.	Description of Item	Unit	Quantity	Rate (Rs.) Including all taxes	Amount (Rs) Including all taxes
1	<b>Providing concrete for plain/reinforced concrete in open foundations complete as per drawings and technical specifications clause 802,803,1202 &amp;1203</b> With crushed stone PCC grade M10, Nominal 1:3:6(hand mixing)	cum	10.125		
2	<b>Stone masonry in cement mortar for substructure complete as per drawing &amp; technical specification Clauses 702, 704, 1202 and 1204</b> In cement mortar 1:4	cum	66.188		
3	Providing weepholes in brick masonry/stone masonry, plain/reinforced concrete abutment, wing wall, return wall with 100 mm dia PVC pipe extending through the full width of the structures with slope of 1(V):20(H) towards drawing face complete as per drawing and technical specification Clauses 614, 709, 1204.3.7 For weepholes pipe 100 mm dia PVC	No.s	50		
4	Plastering with Cement Mortar (1:4), 15 mm thick in substructure as per technical specification For Toe wall plaster Top portion	sqm	65.50		
5	Supplying, fitting and placing TMT (Fe-500 D) reinforcement bar (Other ISI approved TMT reinforcement bar (SAI/BISCON/THERMAX or equivalent)) in substructure complete as per drawings and technical specification Clauses 1002, 1005, 1010 & 1202 8 mm thick jali for drain bed	ton	0.51		
6	Providing and laying filter media with granular crushed aggregates as per specification with smaller size towards the soil and bigger size towards the wall and providing over the entire surface behind	cum	18.75		

	abutment, wing wall, return wall to the full height, compacted to firm condition complete as per drawing and technical specification Clause 1204 3 8				
7	Hiring of diesel compressor including all necessary equipments, transportation of machine to and from site, driller, helper and cost of fuel for making drill holes of dia. 20mm and 500mm deep at the top face of concrete column to fix the reinforcement bars.	day	7.00		
8	Supplying :FOSROC LOCK FIX P " agent for fixing the reinforcement bars into the drill holes	litre	5.00		
9	Supplying, fitting and placing TMT (Fe-500 D) reinforcement bar (From Primary Producer: TATA/SAIL/Esser Steel/ Jindal steel/Shyam steel/RINL) in foundation complete as per drawings and technical specifications Clauses 1000 and 1202 Tor for Dowelling for foundation 20mm dia TMT bar @1000 c/c	ton	0.12		
10	Providing and laying pitching on slopes laid over prepared filter media as per drawing and technical specifications Clause 1302 Stone Boulder	cum	3.75		
<b>(B) Total (Rs.)</b>					

**(C) Construction of 2 nos. stone masonry catch pit at 1st bench of newly excavated area on left bank of upstream side at Dam site of KLHEP.**

Sl. No.	Description of Item	Unit	Quantity	Rate (Rs.) Including all taxes	Amount (Rs) Including all taxes
1	<b>Excavation of Structures</b> Earthwork in excavation for structures as per drawing and technical specifications clause 305.1 including setting out, construction of shoring and bracing, removal of stumps and other deleterious materials and disposal upto a lead of 50m, dressing of sides and bottom and backfilling in trenches with excavated suitable material. Ordinary Soil Upto 3 m depth	cum	19.224		
2	<b>Providing concrete for plain/reinforced concrete I open foundations complete as per drawings and technical specifications clause 802,803,1202 &amp;1203</b> With crushed stone PCC grade M10, Nominal 1:3:6(hand mixing)	cum	0.16		
3	Providing concrete for plain/reinforced concrete open foundations complete as per drawings and technical specifications clause 802,803,1202 &1203 With crushed stone R.C. C grade M20	cum	1.344		
4	Stone masonry in cement mortar for substructure complete as per drawing & technical specification Clauses 702, 704, 1202 and 1204	cum	9.386		

	Random rubble masonry In cement mortar 1:4				
5	Providing and laying boulder apron for bed protection with stone boulders of minimum size and weight as per Table 1300.1, no fragment weighing less than 25 kg laid dry complete as per drawing and technical specifications Clause 1301 Wall	cum	2.02		
6	Supplying, fitting and placing TMT (Fe-500 D) reinforcement bar (Other ISI approved TMT reinforcement bar (SAI/BISCON/THERMAX or equivalent)) in substructure complete as per drawings and technical specification Clauses 1002, 1005, 1010 & 1202	ton	0.05		
7	Plastering with Cement Mortar (1:4), 15 mm thick on brickwork in substructure as per technical specification	sqm	97.6		
				<b>(C)Total(Rs.)</b>	

**Grand Total: (A)+(B)+(C)=**

<b>BIDDER'S CREDENTIALS</b>		
<b>Particulars</b>	<b>Validity period</b>	<b>Supporting documents</b>
1. Financial status (Average Annual Turnover for the F.Y. 2018-19, 2019-20 & 2020-21)  2. PAN  3. Active GST Registration certificate  4. Registration certificate of firm(if any)  5. Labour Licence  6. E.P.F  7. List of similar works previously executed  8. ITR return for preceding two FY  9. Others		
Note: 1) Bidder should furnish supporting documents. Otherwise information given in the tender shall not be considered for evaluation.		

Enclose:

1. Demand Draft No.
2. Date of issue
3. Name of Bank

Yours faithfully,

Signature of contractor

Full Name

Address

# CHAPTER-IX

## DRAWINGS

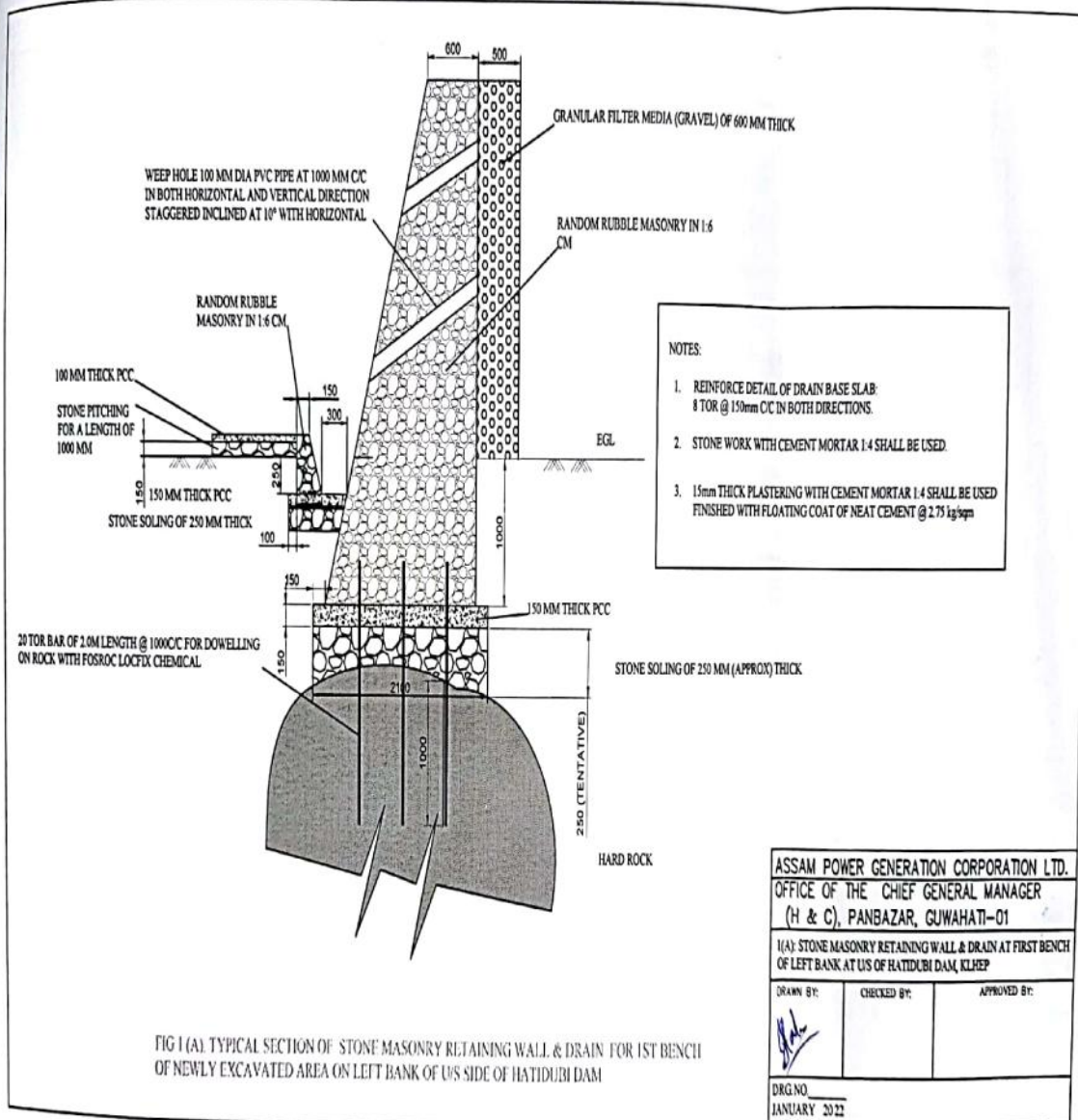
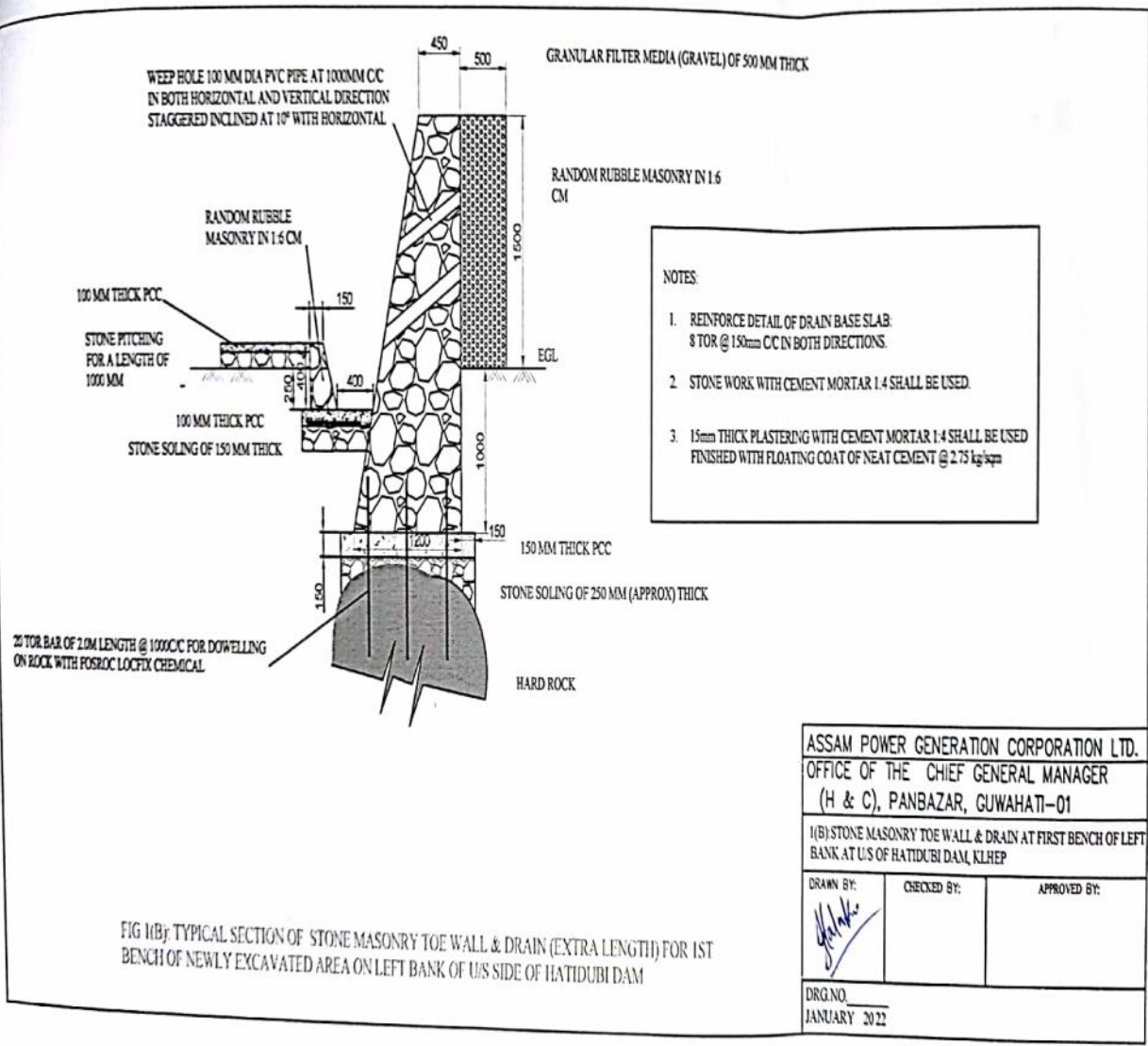

FIG 1 (A). TYPICAL SECTION OF STONE MASONRY RETAINING WALL & DRAIN FOR 1ST BENCH OF NEWLY EXCAVATED AREA ON LEFT BANK OF US SIDE OF HATIDUBI DAM





- NOTES:
1. REINFORCE DETAIL OF DRAIN BASE SLAB:  
8 TOR @ 150mm CC IN BOTH DIRECTIONS.
  2. STONE WORK WITH CEMENT MORTAR 1:4 SHALL BE USED.
  3. 15mm THICK PLASTERING WITH CEMENT MORTAR 1:4 SHALL BE USED FINISHED WITH FLOATING COAT OF NEAT CEMENT @ 2.75 kg/sqm

ASSAM POWER GENERATION CORPORATION LTD.		
OFFICE OF THE CHIEF GENERAL MANAGER (H & C), PANBAZAR, GUWAHATI-01		
1/(B) STONE MASONRY TOE WALL & DRAIN AT FIRST BENCH OF LEFT BANK AT U/S OF HATIDUBI DAM, KLHEP		
DRAWN BY: <i>[Signature]</i>	CHECKED BY:	APPROVED BY:
DRG NO. _____ JANUARY 2022		

FIG 1(B): TYPICAL SECTION OF STONE MASONRY TOE WALL & DRAIN (EXTRA LENGTH) FOR 1ST BENCH OF NEWLY EXCAVATED AREA ON LEFT BANK OF U/S SIDE OF HATIDUBI DAM

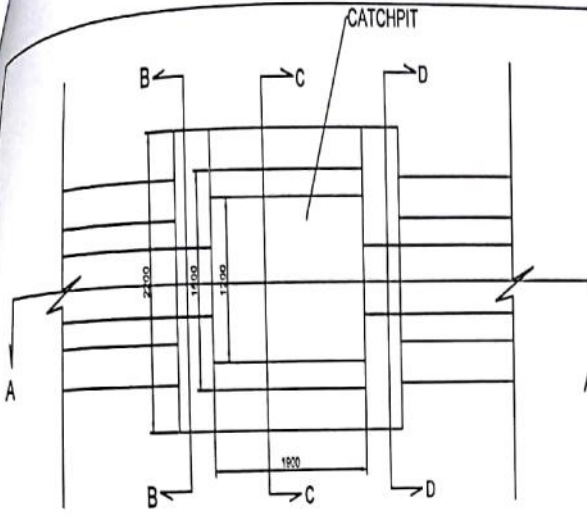

**FIG: PLAN OF CATCHPIT**

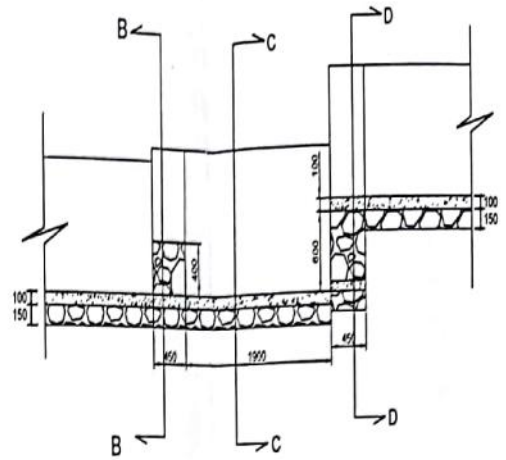

**FIG: SECTIONAL ELEVATION A-A**

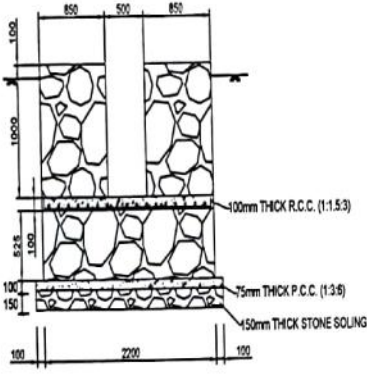

**SECTION D-D**

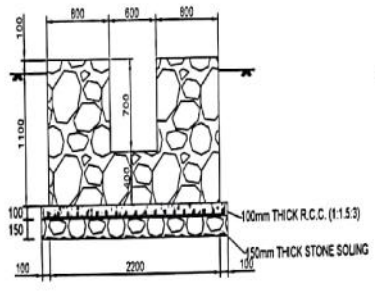

**SECTION B-B**

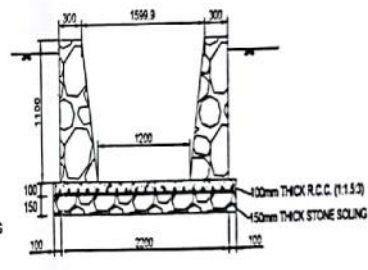

**SECTION C-C**

- NOTES:**
1. REINFORCE DETAIL OF DRAIN BASE SLAB: 8 TOR @ 150mm C/C IN BOTH DIRECTIONS.
  2. STONE WORK WITH CEMENT MORTAR 1:4 SHALL BE USED.
  3. 15mm THICK PLASTERING WITH CEMENT MORTAR 1:4 SHALL BE USED FINISHED WITH FLOATING COAT OF NEAT CEMENT @ 2.75 kg/sqm

ASSAM POWER GENERATION CORPORATION LTD.		
OFFICE OF THE CHIEF GENERAL MANAGER		
(H & C), PANBAZAR, GUWAHATI-01		
1/3 PLAN, ELEVATION AND SECTION OF CATCHPIT AT FIRST BENCH OF LEFT BANK AT US OF HATELBE DAM, KLHEP		
DRAWN BY:	CHECKED BY:	APPROVED BY:
<i>[Signature]</i>		
ORIGINAL JANUARY 2012		

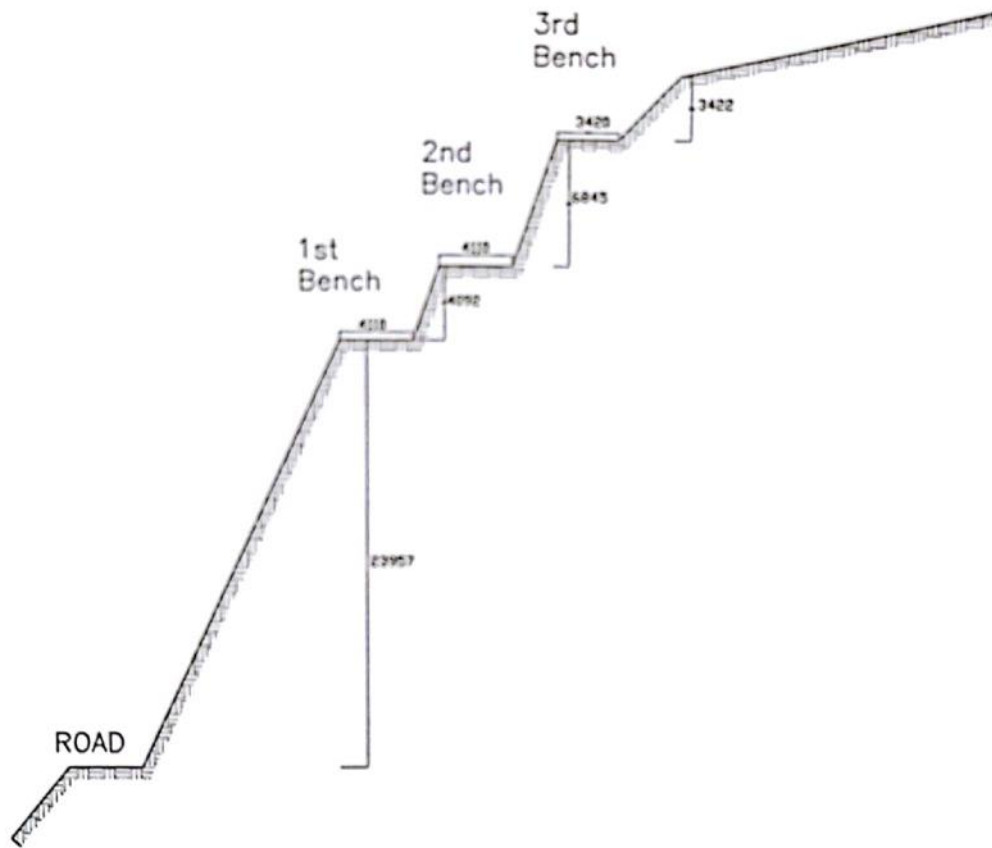

EXISTING HILL SLOPE PROFILE ON THE  
LEFT BANK OF HATIDUBI DAM.